

row: 1, col: 1

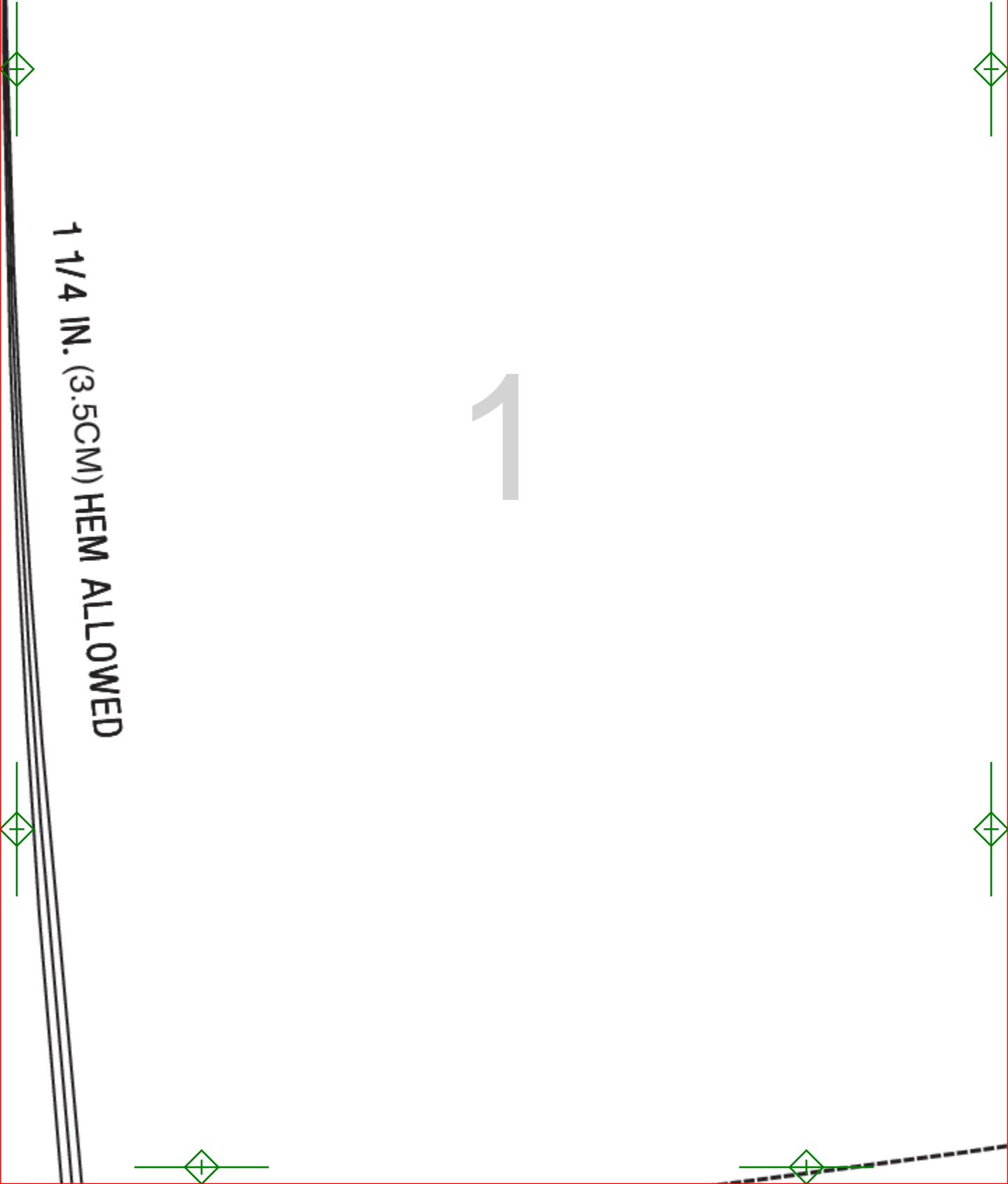

1

1 1/4 IN. (3.5CM) HEM ALLOWED



WAISTLINE

CASING LINE

2

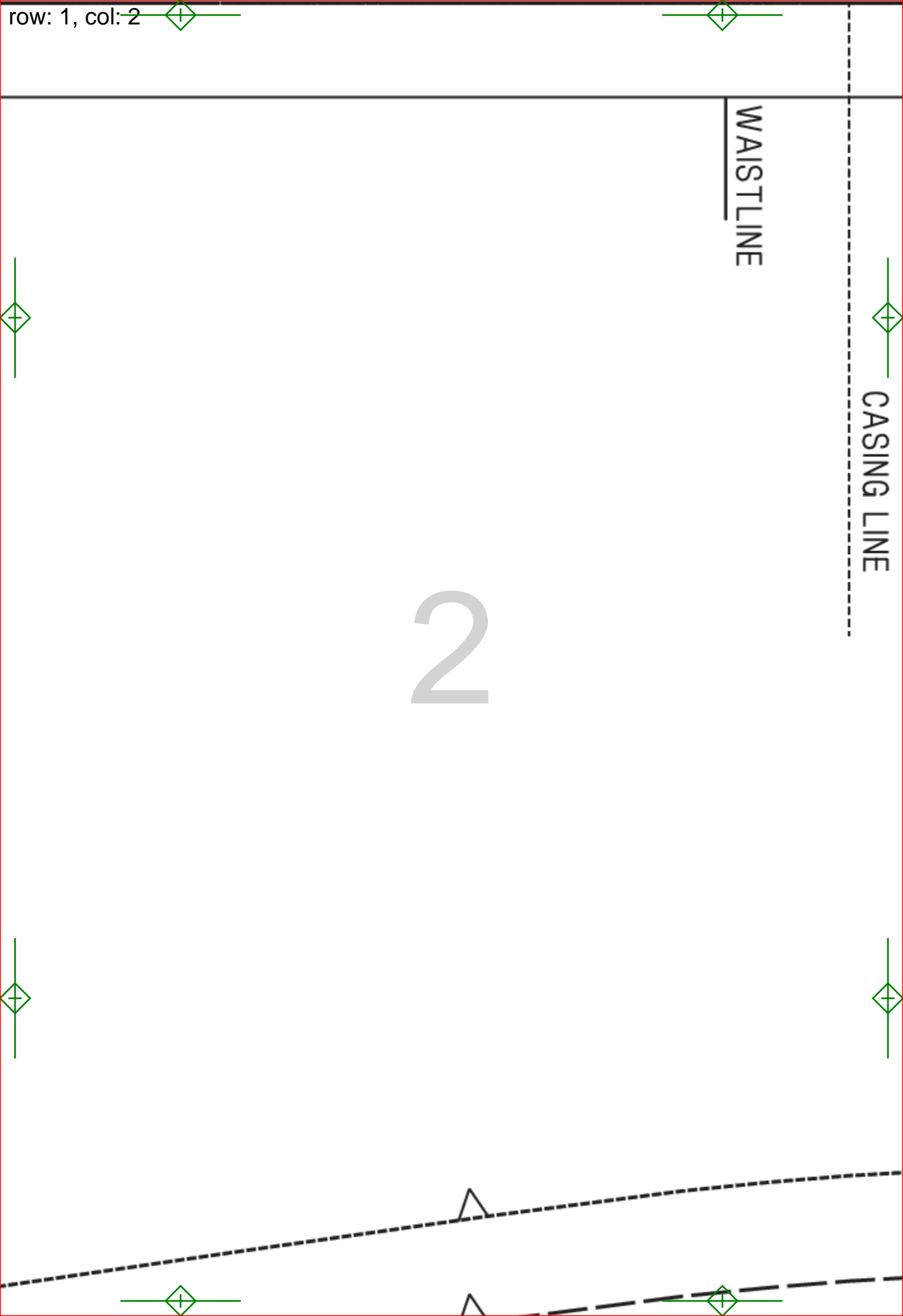

CENTER FOLD

CASING LINE

3

S

M

3/8 IN. (1cm) SEAM ALLOWANCE

5

4

BACK

CUT 1 ON FOLD

McCall's

M8172

Miss size A(S-M-L)



S O

M O

L O



row: 1, col: 5

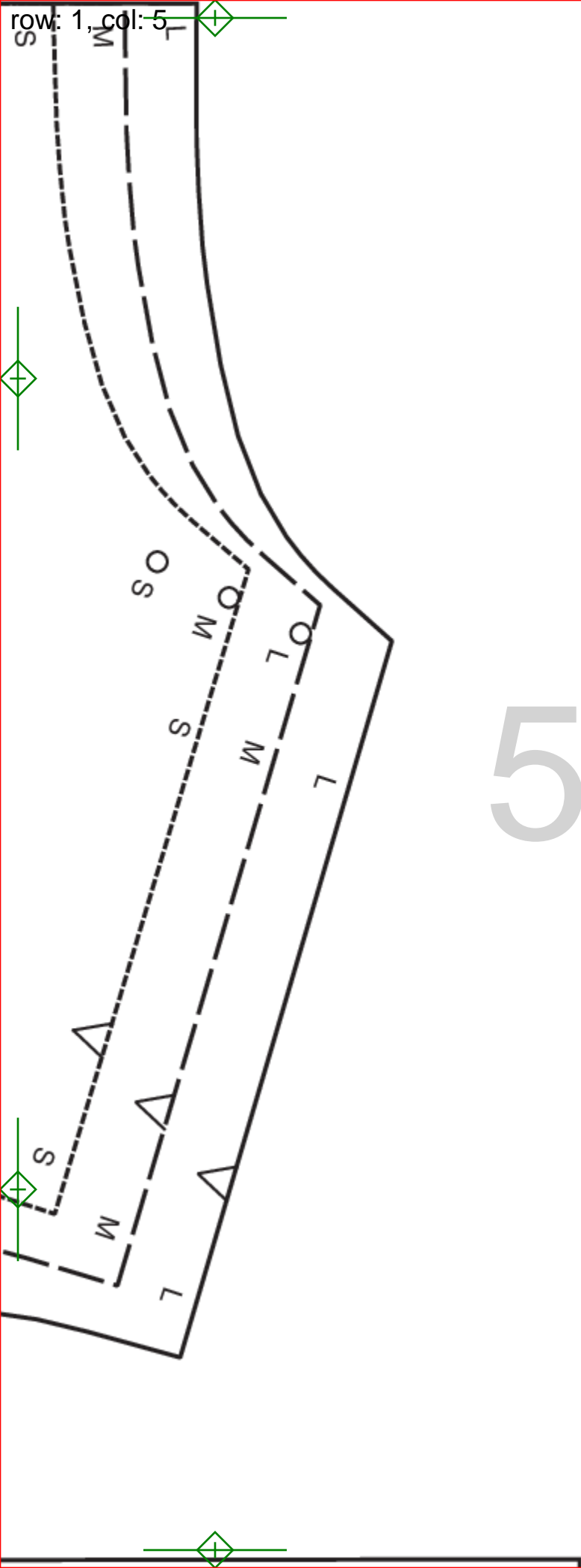

5

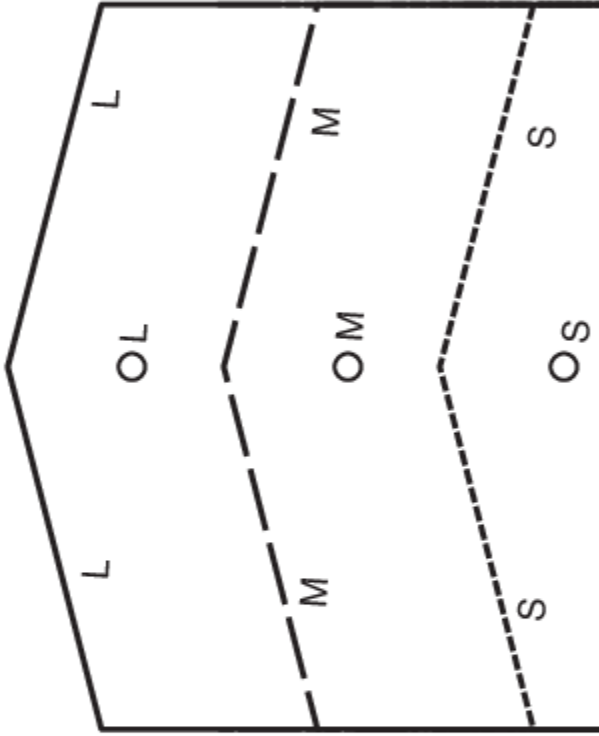
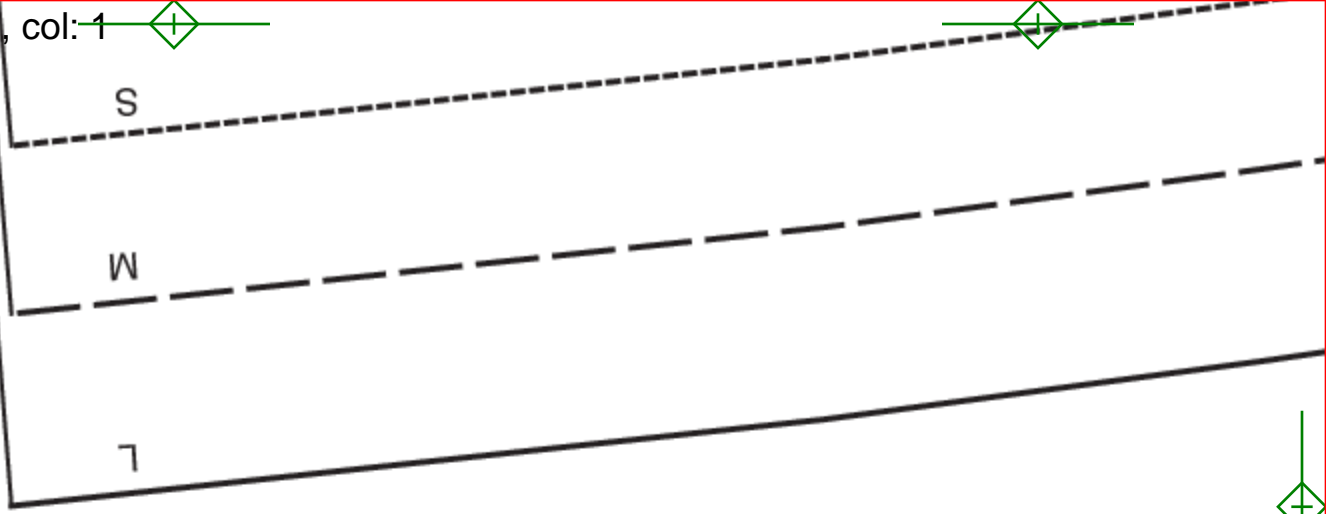

6

2

NECK BAND
CUT 2

McCall's



VED

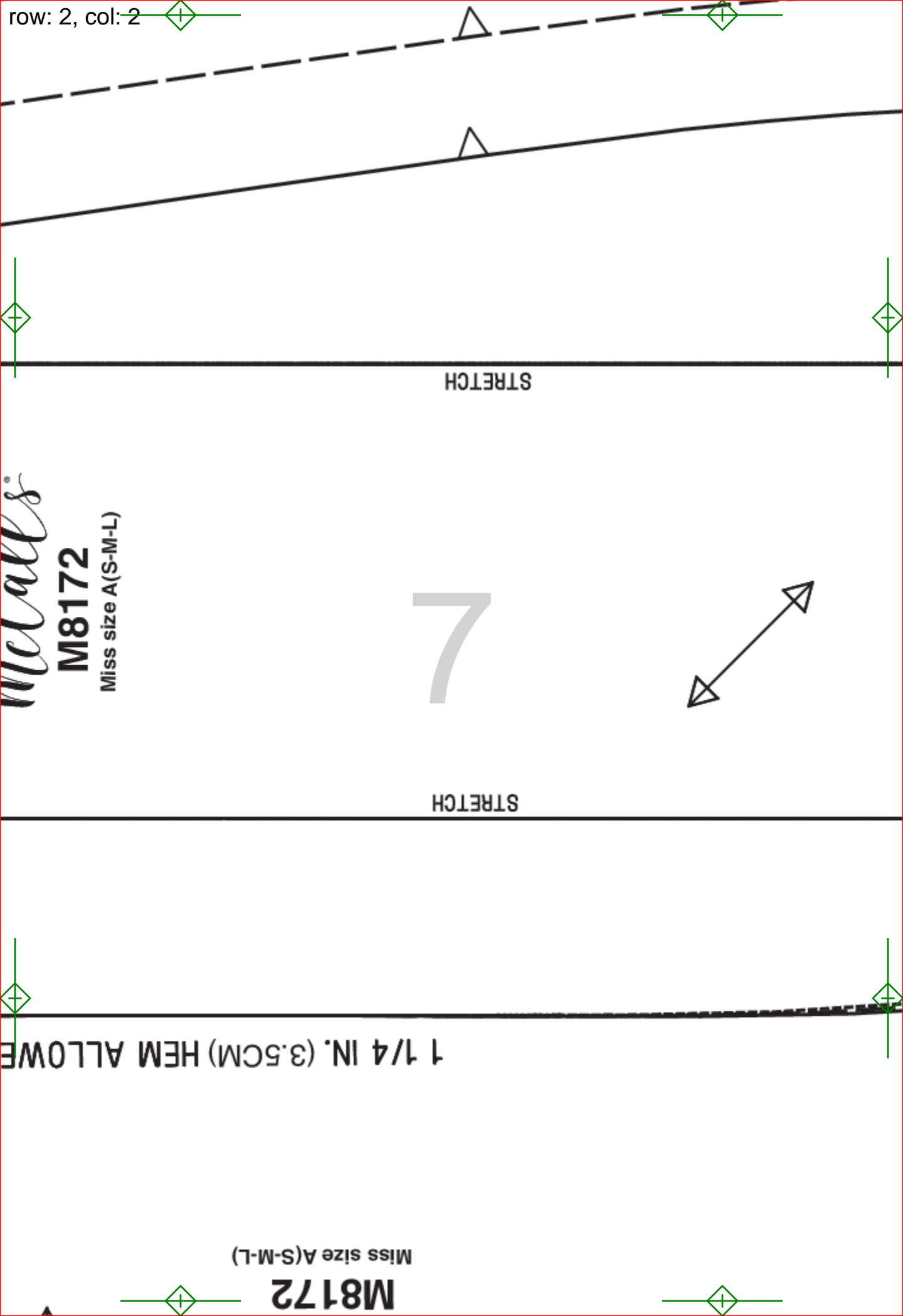

McCall's
M8172
 Miss size A(S-M-L)

7

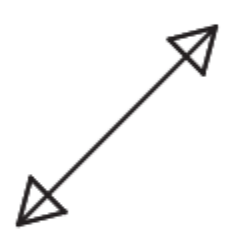

STRETCH

STRETCH

1 1/4 IN. (3.5CM) HEM ALLOWANCE

Miss size A(S-M-L)

M8172

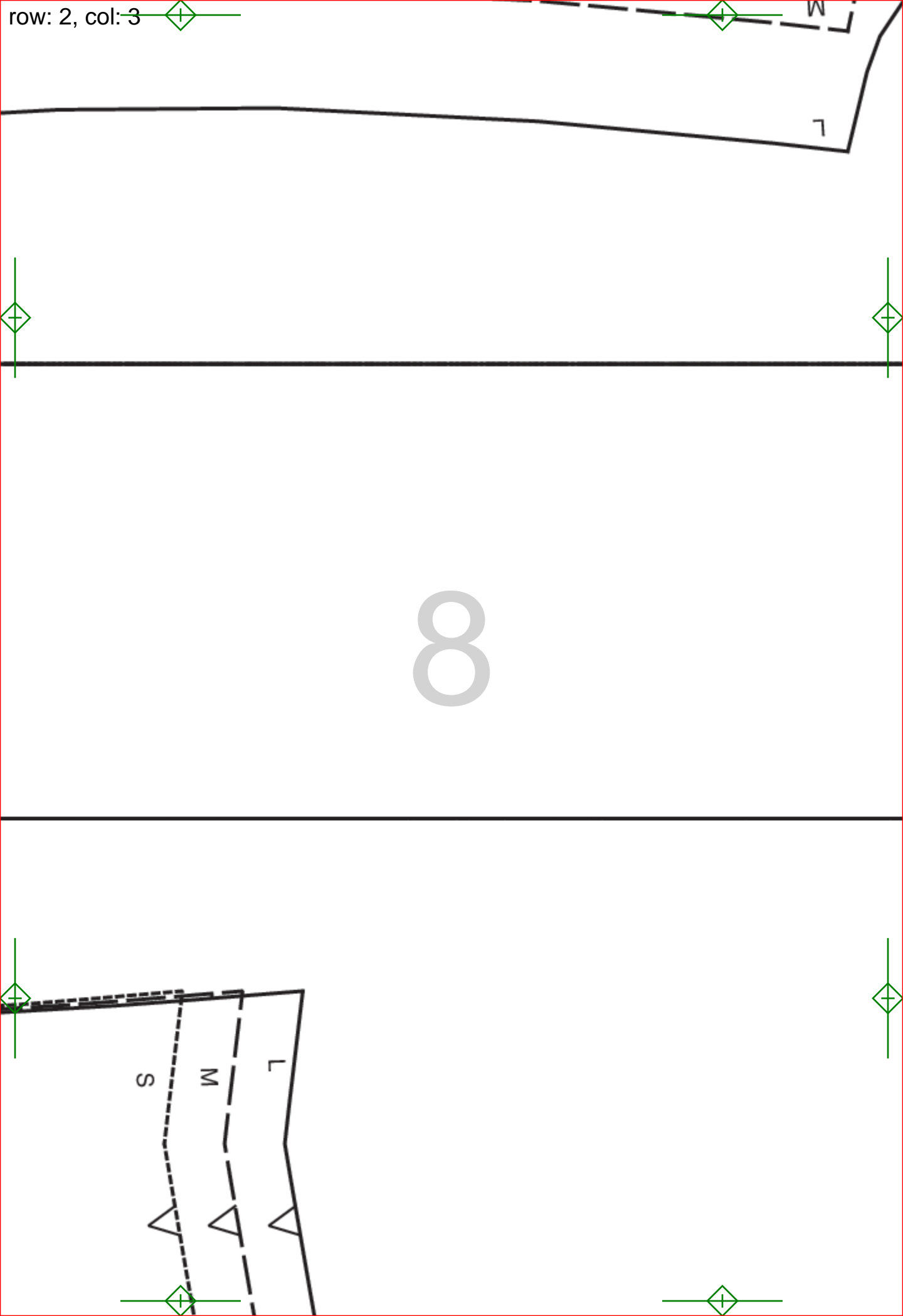

8

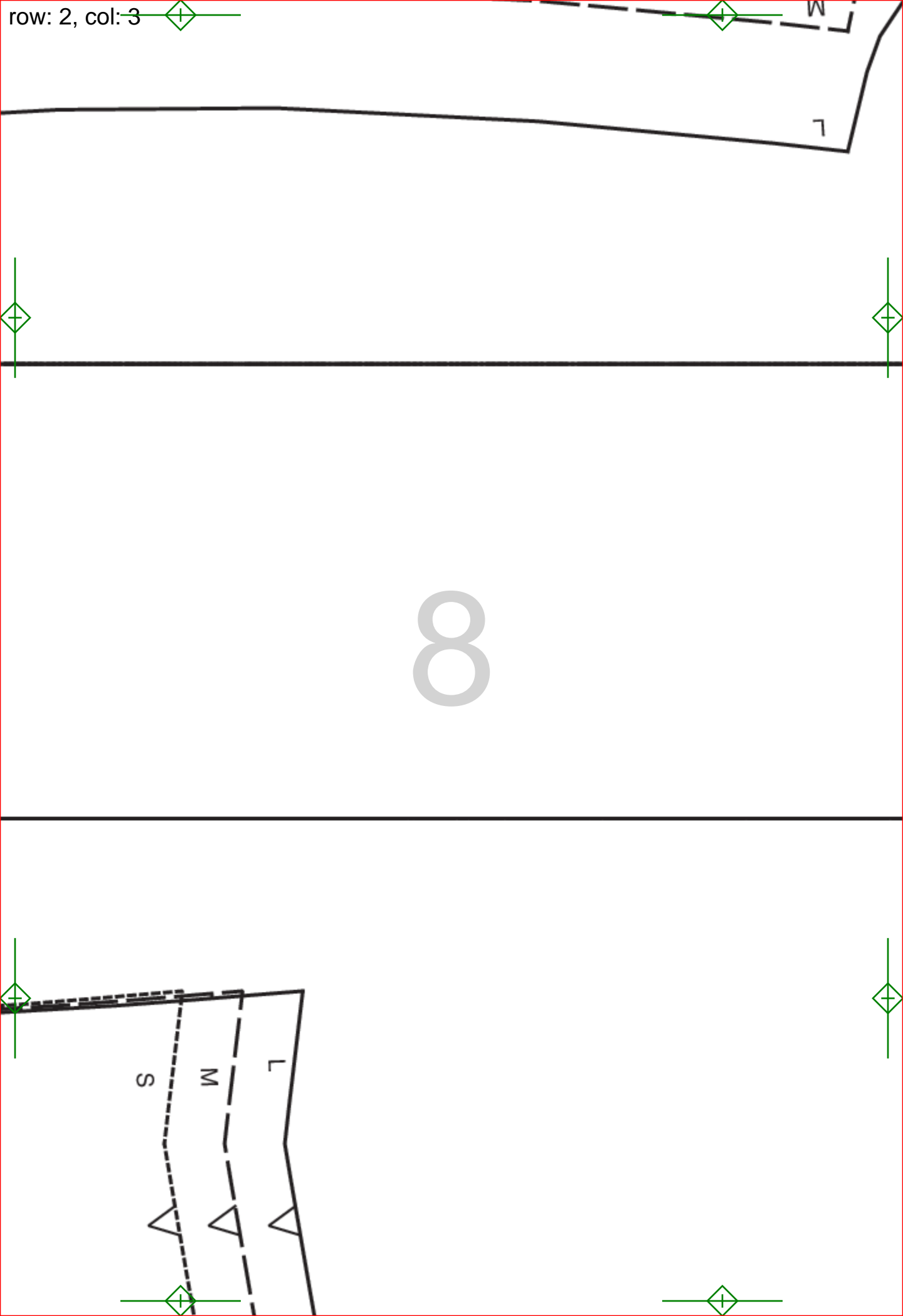
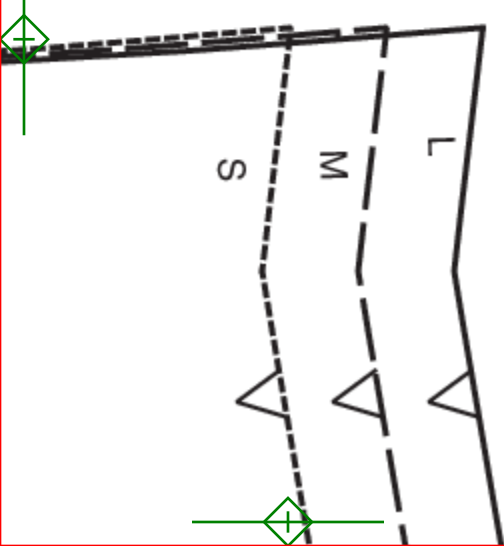

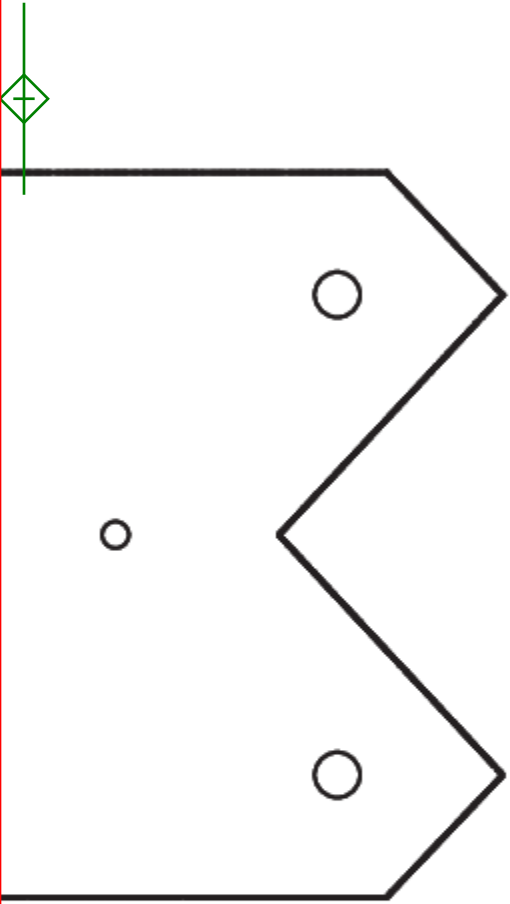

9

FOLD L

4

POCKET

CUT 1

McCall

M8172

Miss size A(S)

LINE

ET

all's
72
A(S-M-L)

10

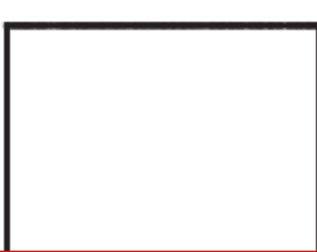

row: 3 col: 1

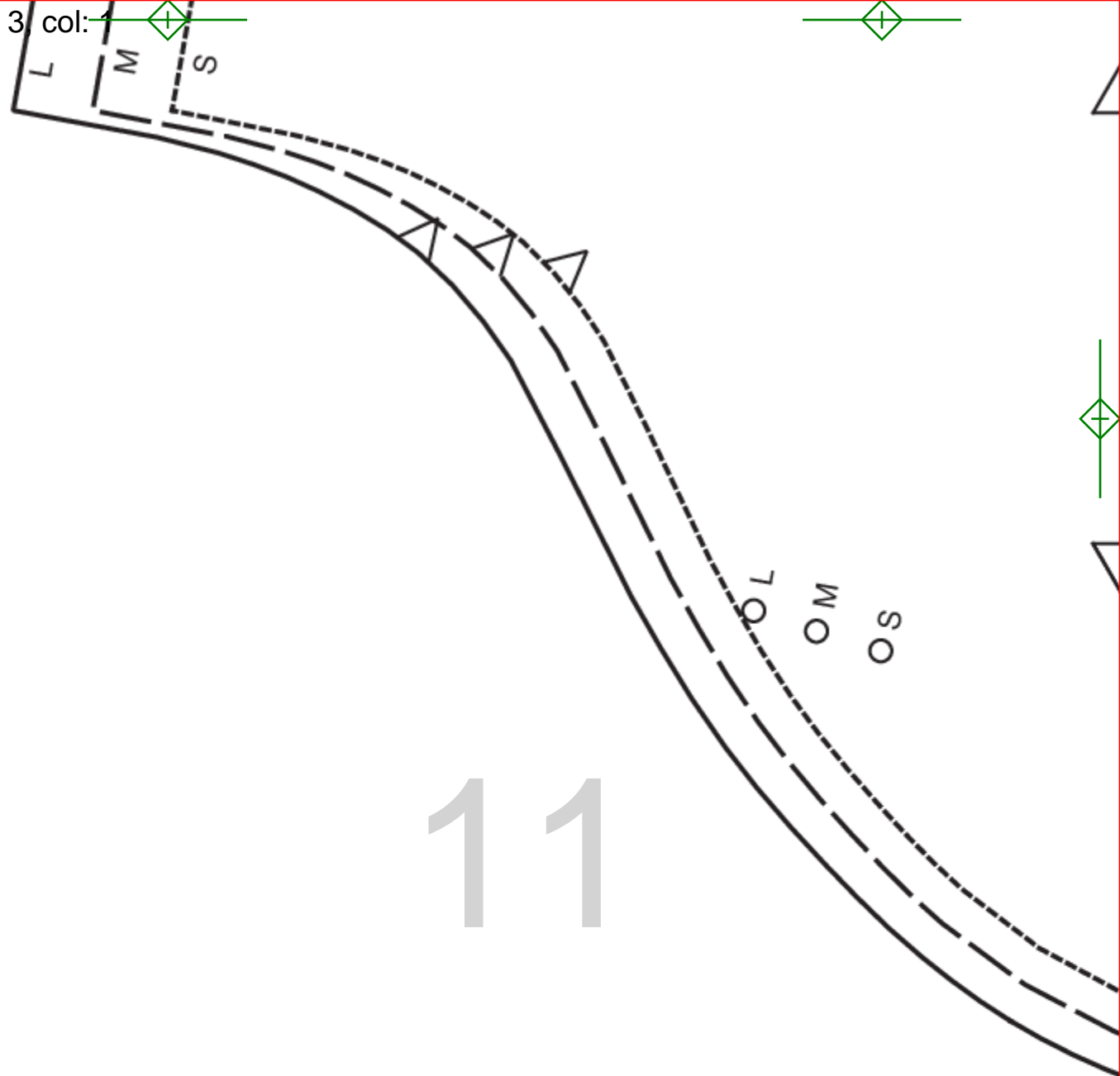

11

McCall's
M8172

SLEEVE
CUT 2
9

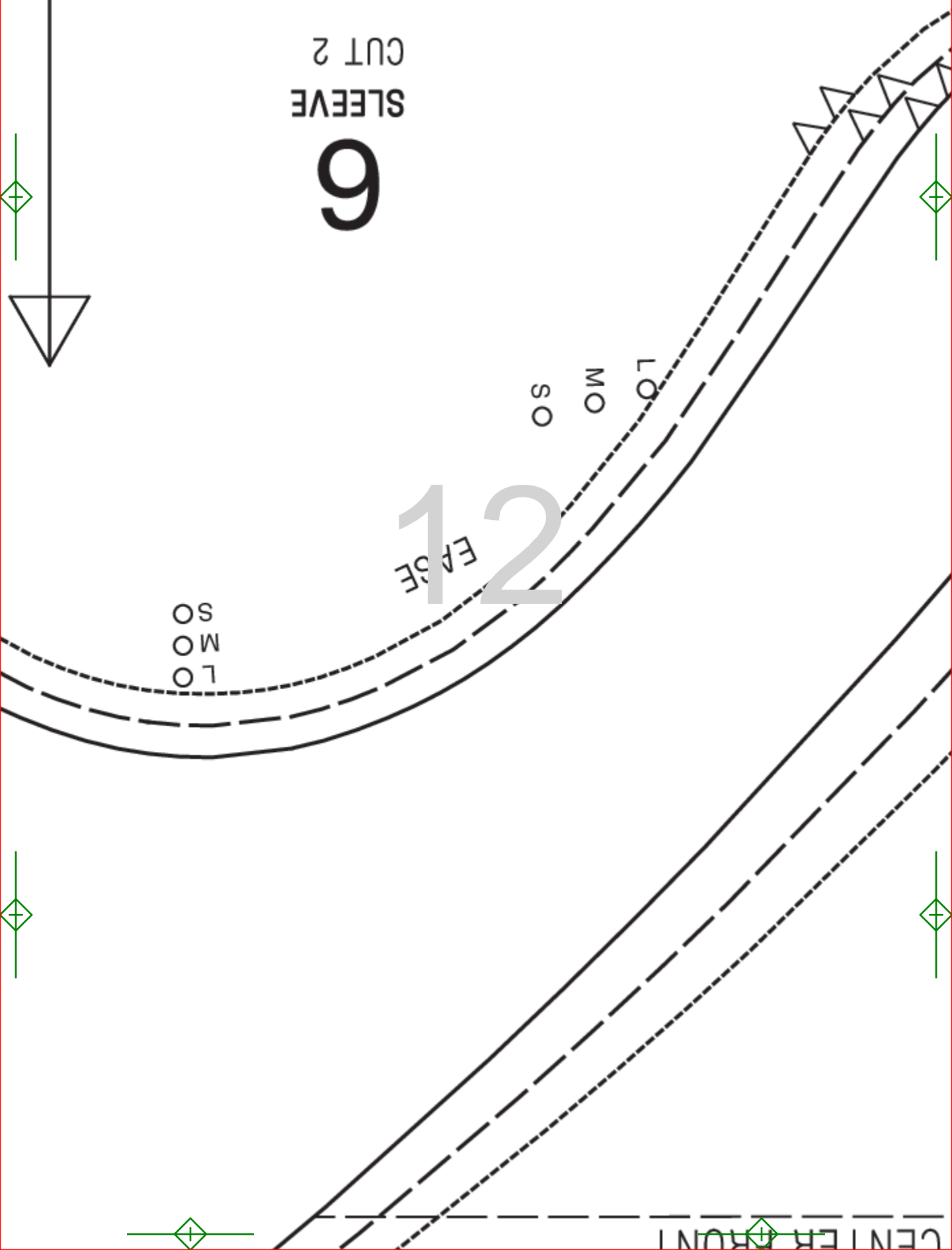
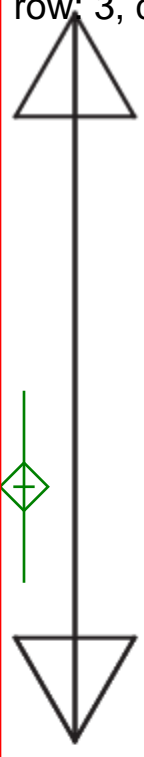

12

LO
MO
SO

LO
MO
SO

row: 3, col: 3

S

M

L

OL

OM

OS

13



0

E

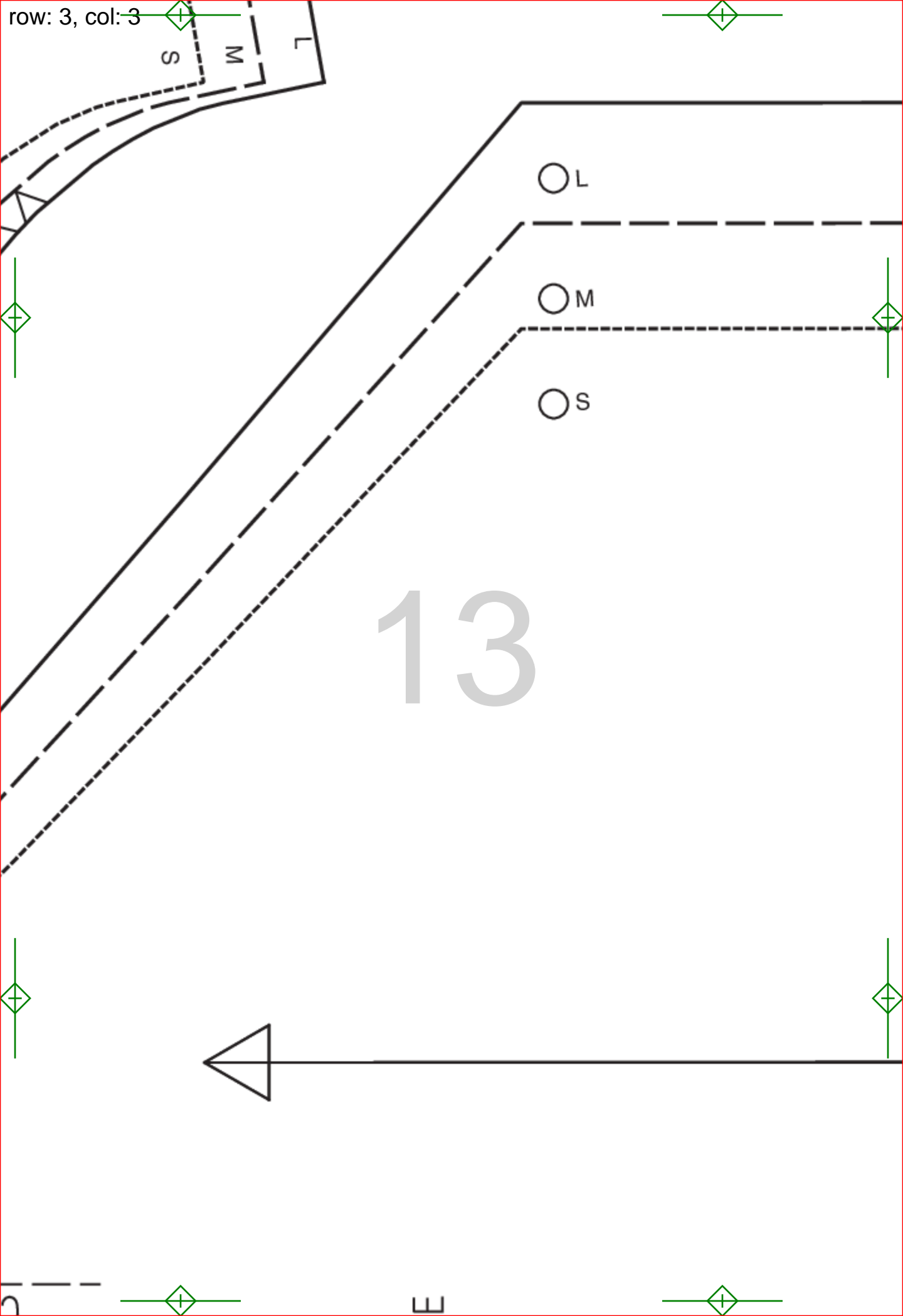

L

M

S

5/8 IN. (1.5cm) HEM ALLO

14





3
 FRONT TIE END
 CUT 2

McCall's
M8172
 Miss size A(S-M-L)

M ALLOWED



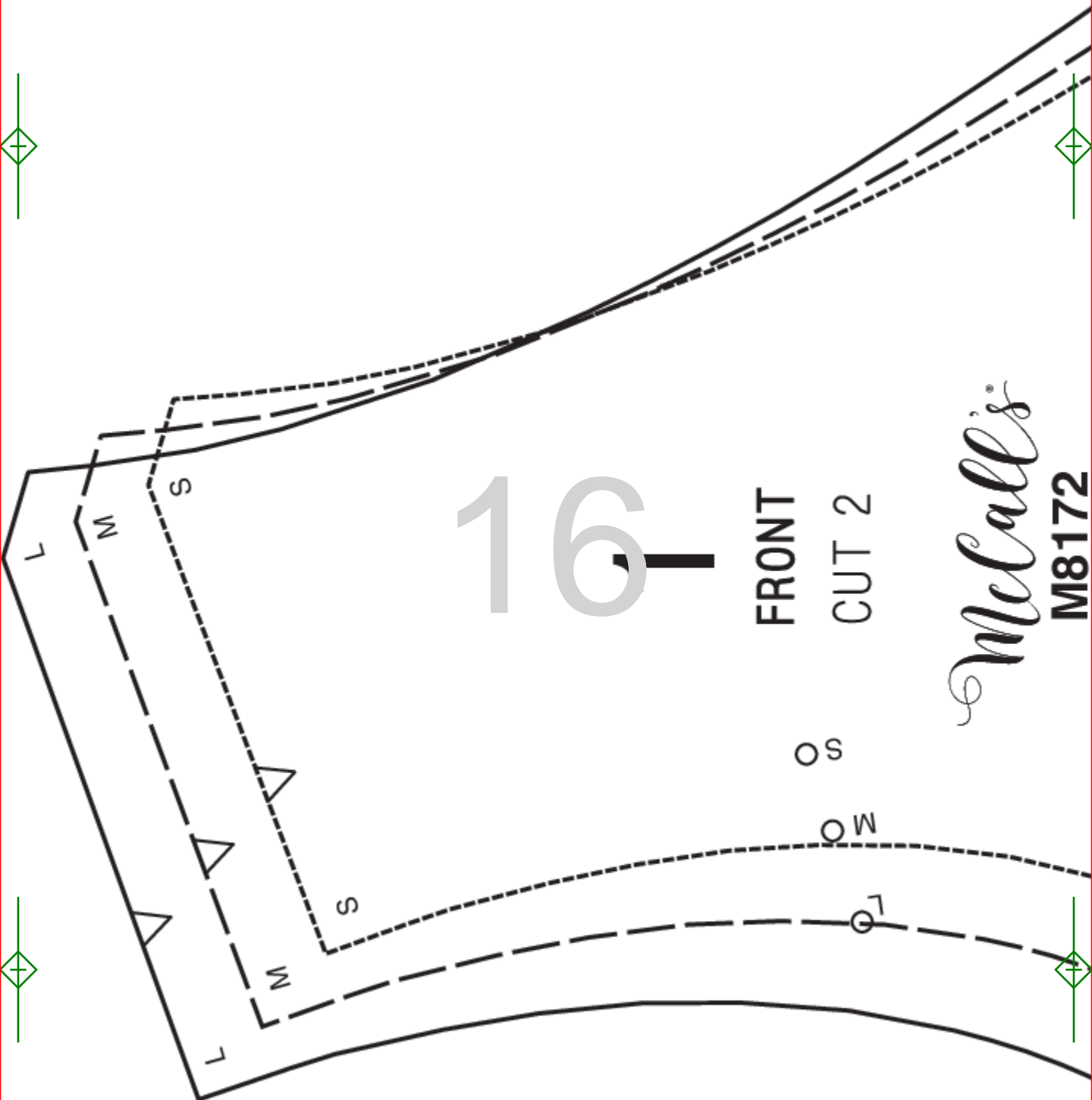

16

FRONT
CUT 2

McCall's

M8172

S

M

L

S

M

L

M8172

Miss size A(S-M-L)

© 2020 a CSS Industries, Inc. brand
All Rights Reserved
Printed in U.S.A.

17

FINISHED GARMENT MEASUREMENTS

- S 38" (96.5 CM)
- M 41 1/2" (106CM)
- L 45 1/2" (116 CM)

* TOTAL EASE ABOVE BUST
BODY MEASUREMENT IS
APPROXIMATELY: 5 1/2" 14CM

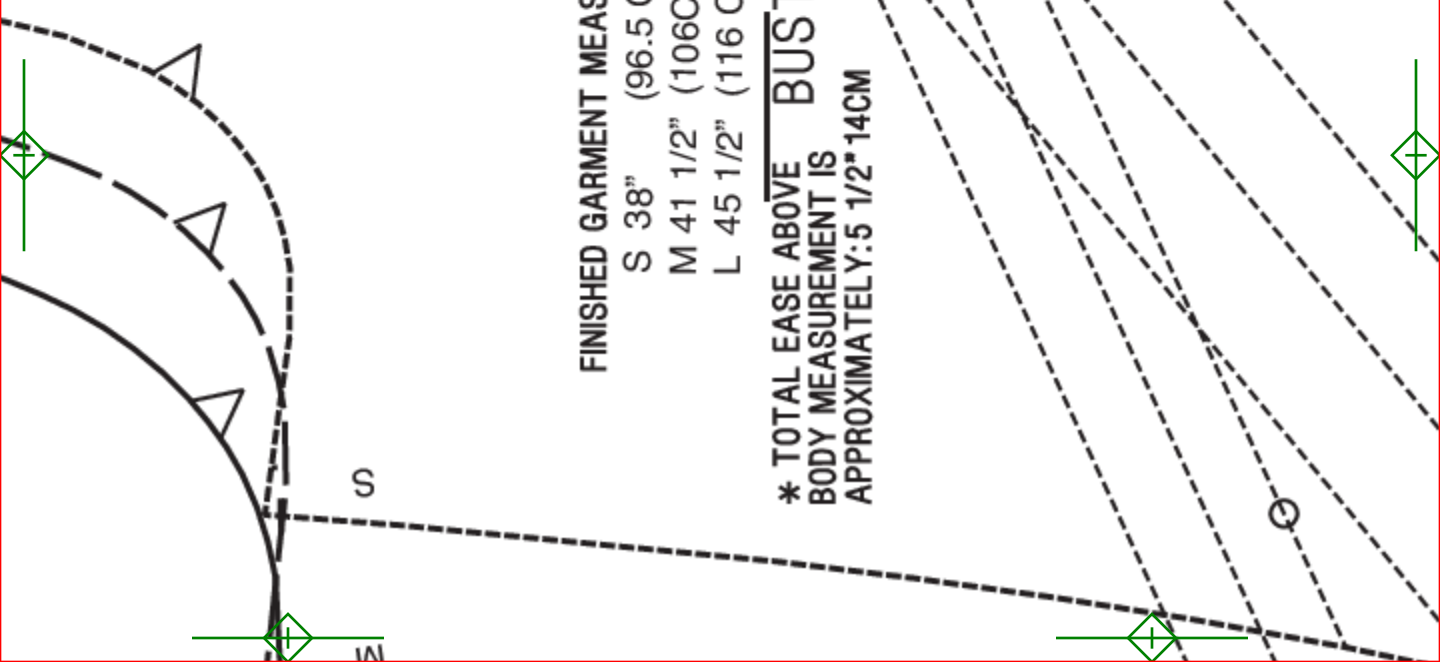

WAISTLINE

18

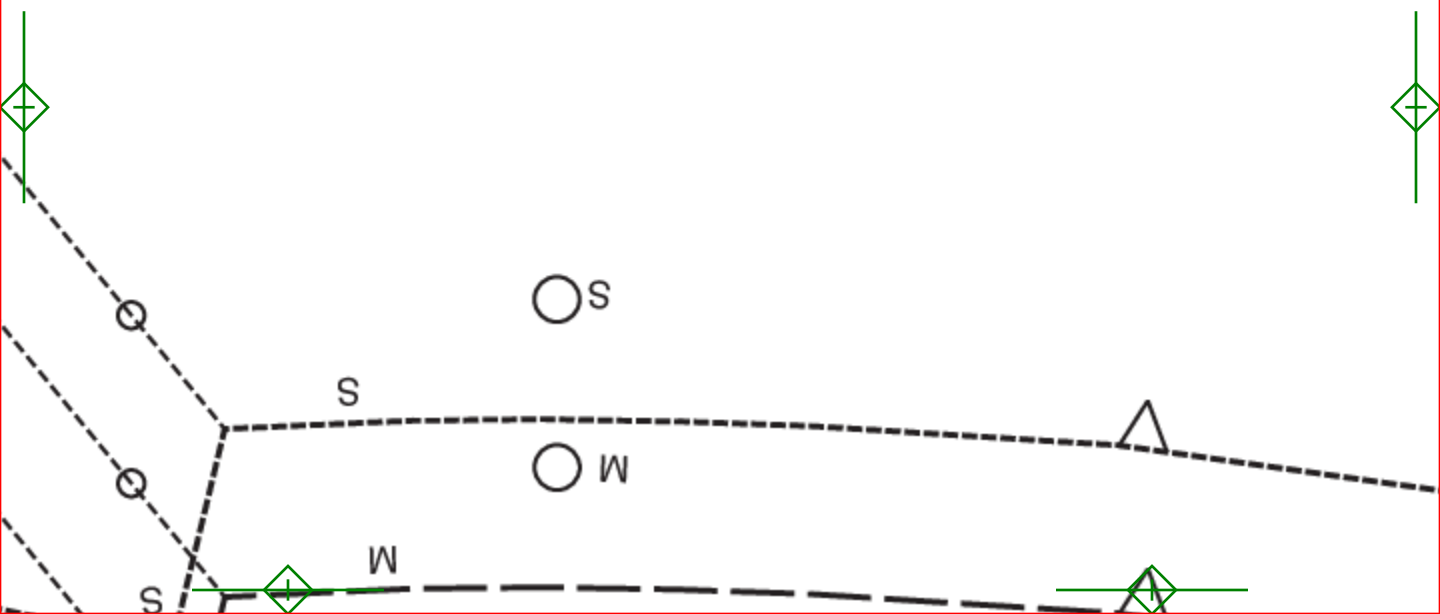

S

POCKET LINE RIGHT SIDE ONLY

M

POCKET LINE RIGHT SIDE ONLY

L

POCKET LINE RIGHT SIDE ONLY

19

S

POCKET LINE RIGHT SIDE ONLY

M

POCKET LINE RIGHT SIDE ONLY

L

POCKET LINE RIGHT SIDE ONLY





1 1/4 IN. (3.5CM) HEM

20



s





21



row: 5, col: 2

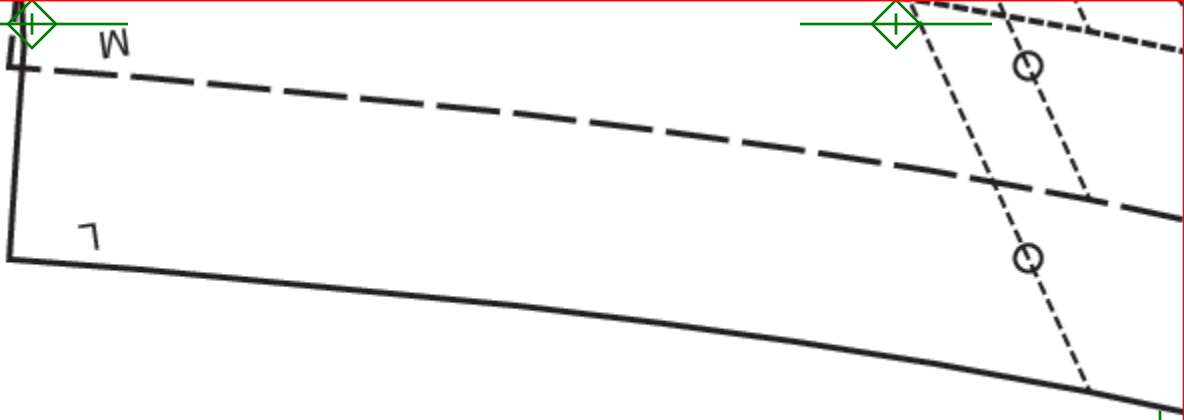

22

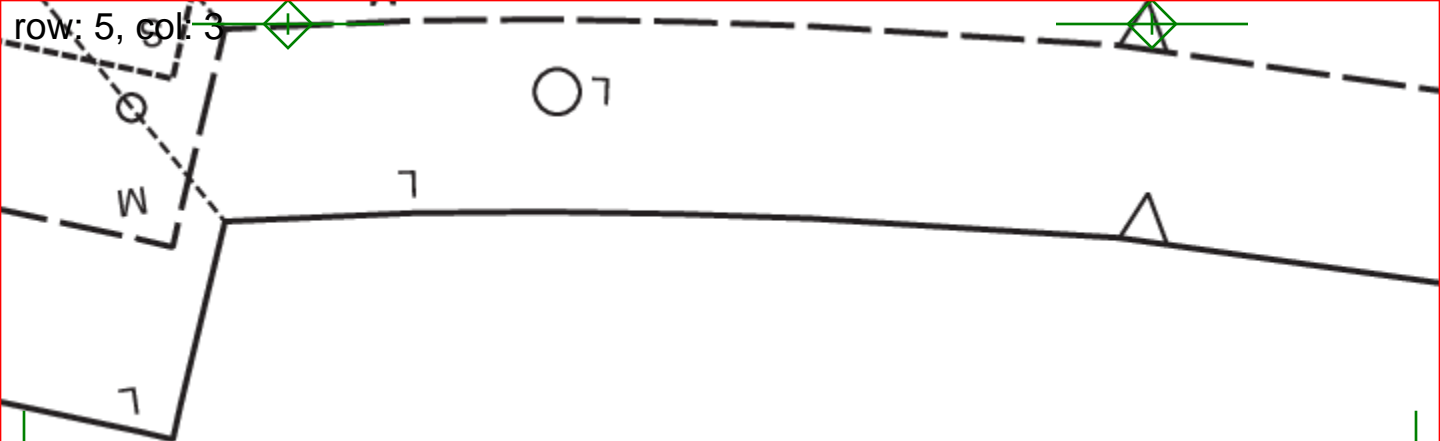

23

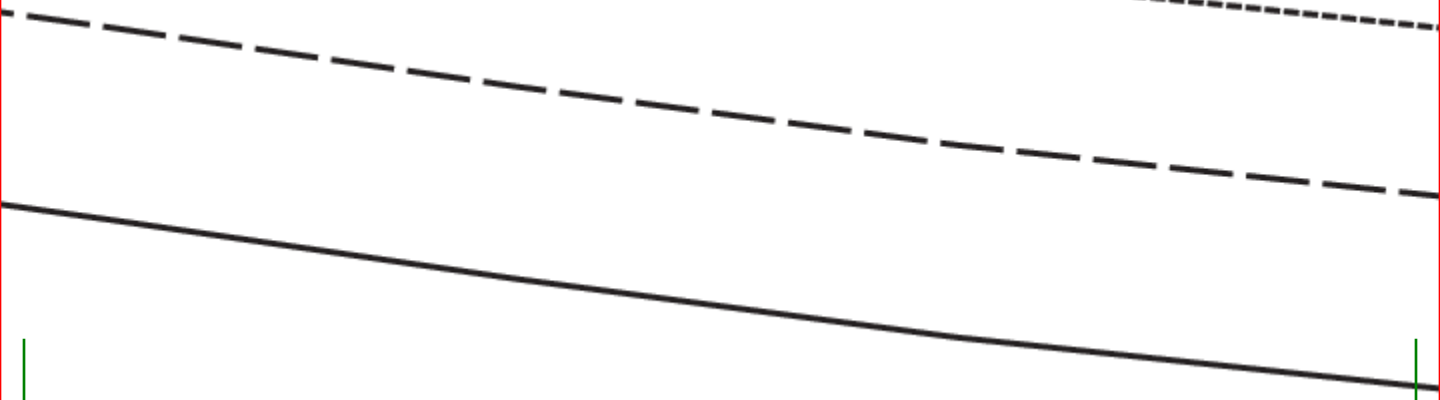

24



row: 5, col: 5

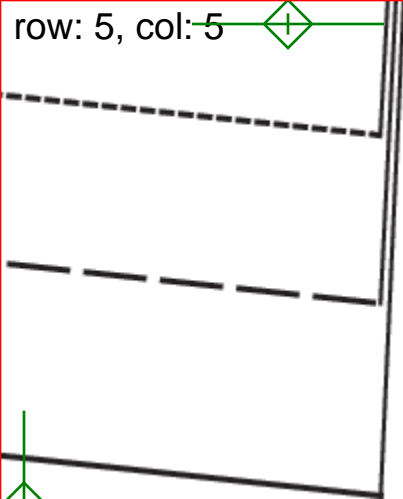

25