

2

2

BACK
DOS
ESPALDA
RÜCKENTEIL
DIETRO

Cut 2

McCall's

M8170

Men's Sizes A (S-M-L)



3

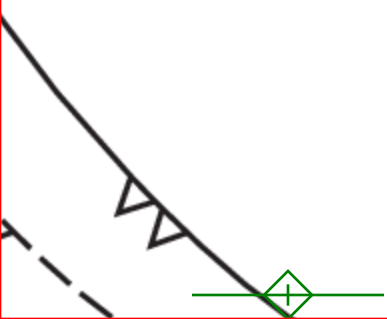

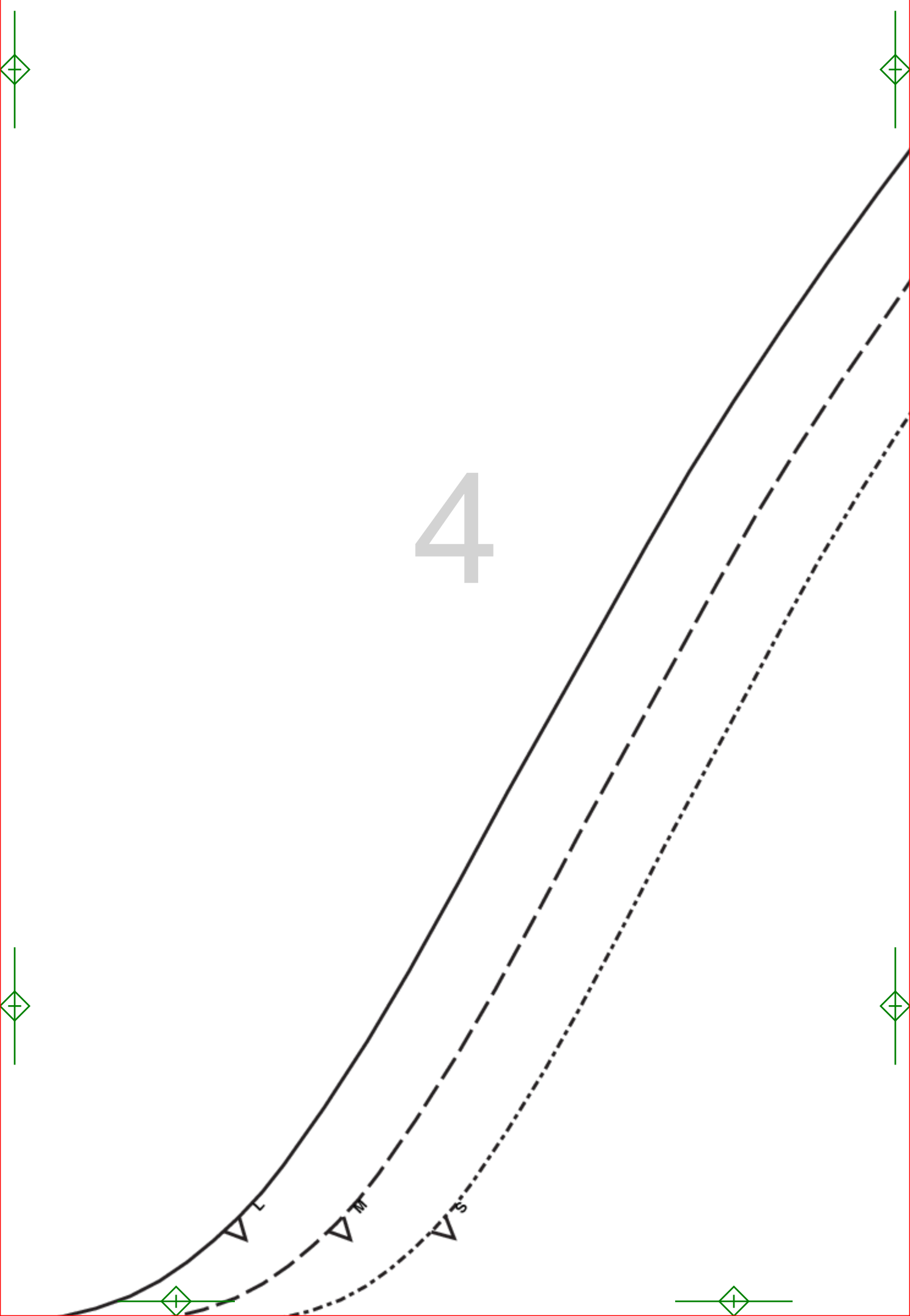

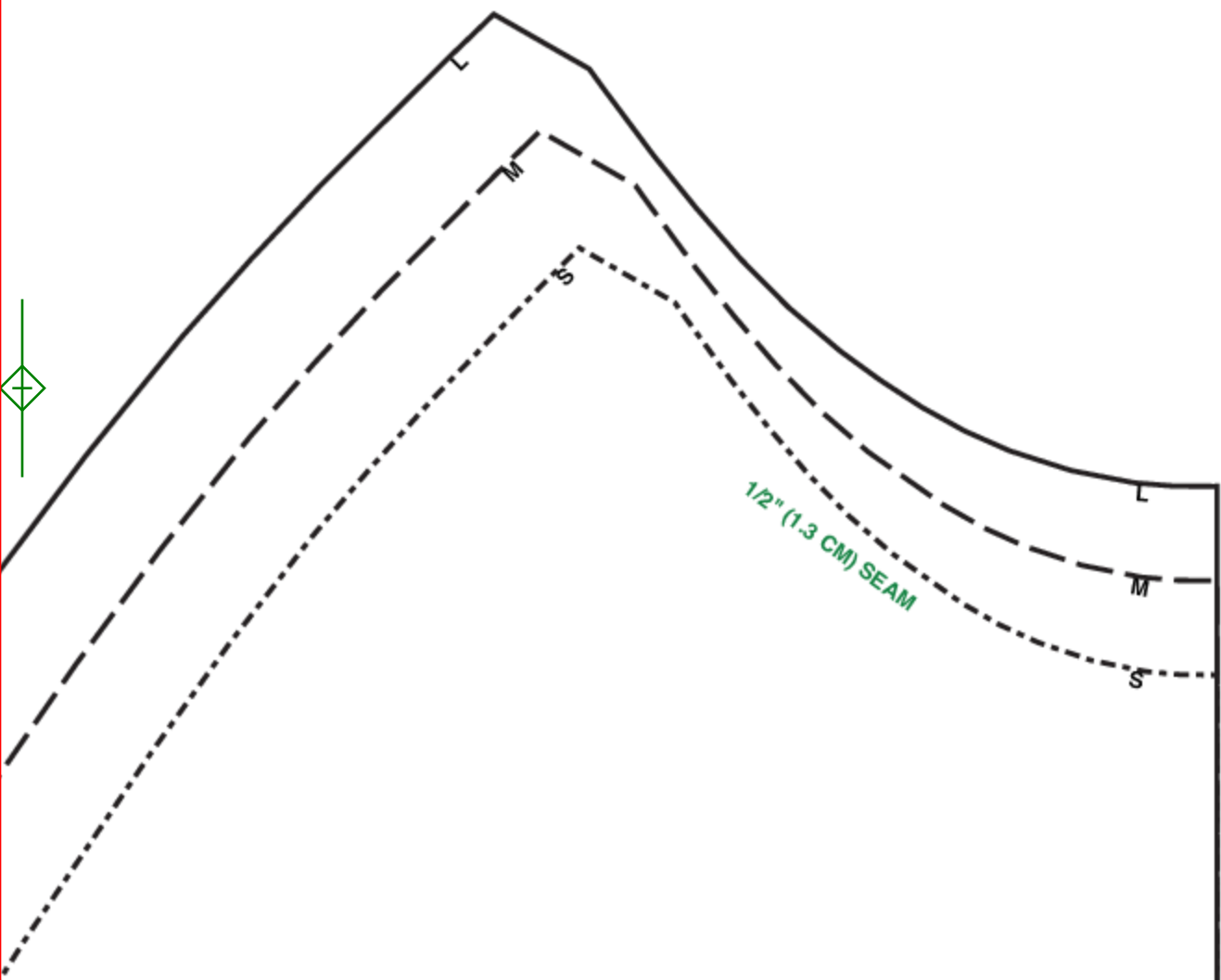

1 5

FRONT
 DEVANT
 FRENTE
 VORDERTEIL
 DAVANTI

Cut 1 on fold

McCall's

@2020 a CSS Industries, Inc. Brand
 All Rights Reserved
 Printed in U.S.A.

M 8170

Men's Sizes A (S-M-L)

CENTER FRONT ON FOLD

L

M

S

FOR RIGHT SIDE

L

M

S

FOR LEFT SIDE

6
AIS INE



LENGTHEN OR SHORTEN HERE

7



row: 2, col: 3

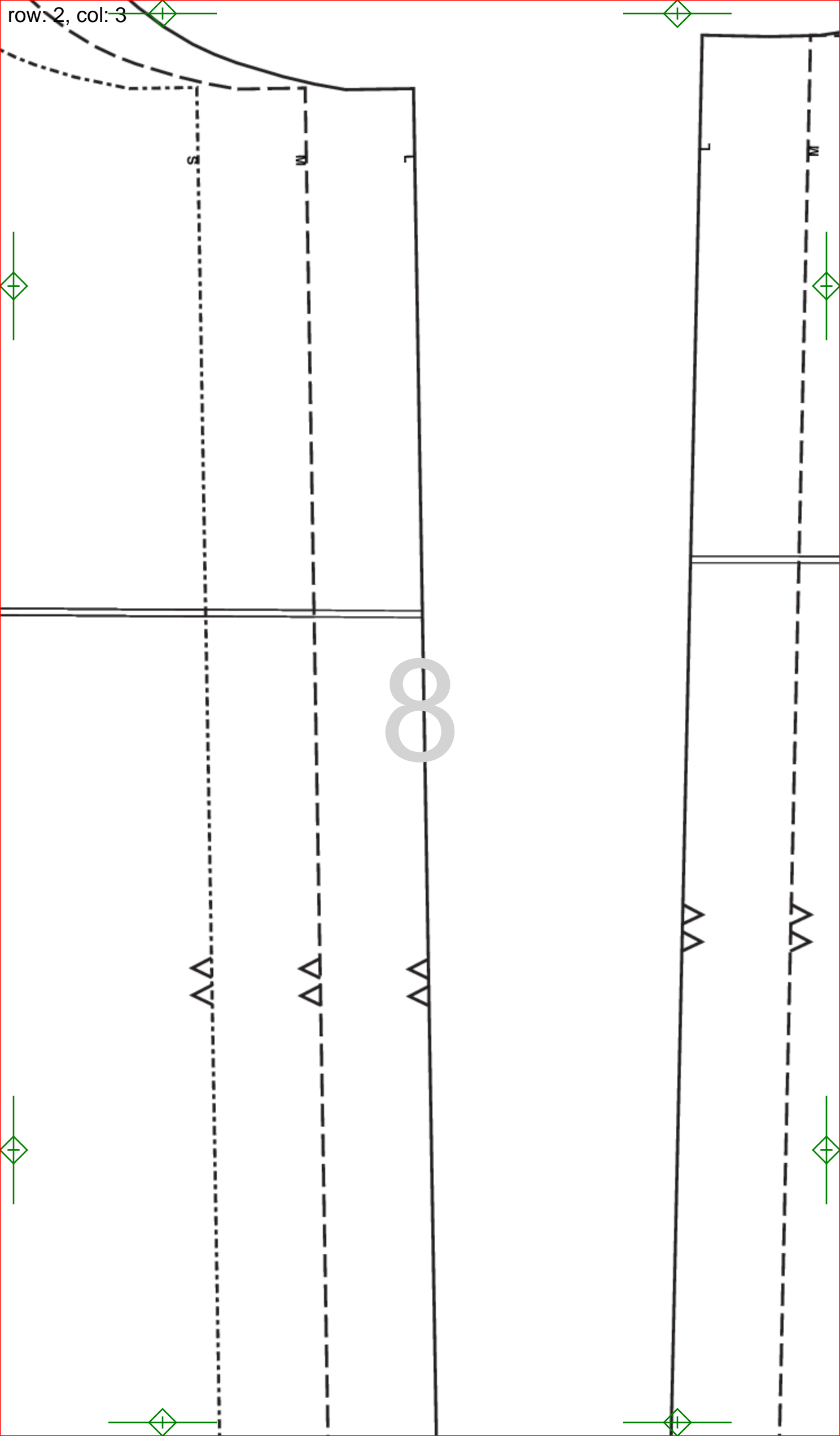

W

S

LENGTH

9

W



S 51" (130CM)
M 55" (140CM)
L 59" (151CM)

LENGTHEN OR SHORTEN HERE

WAISTLINE

10

row: 3, col: 1

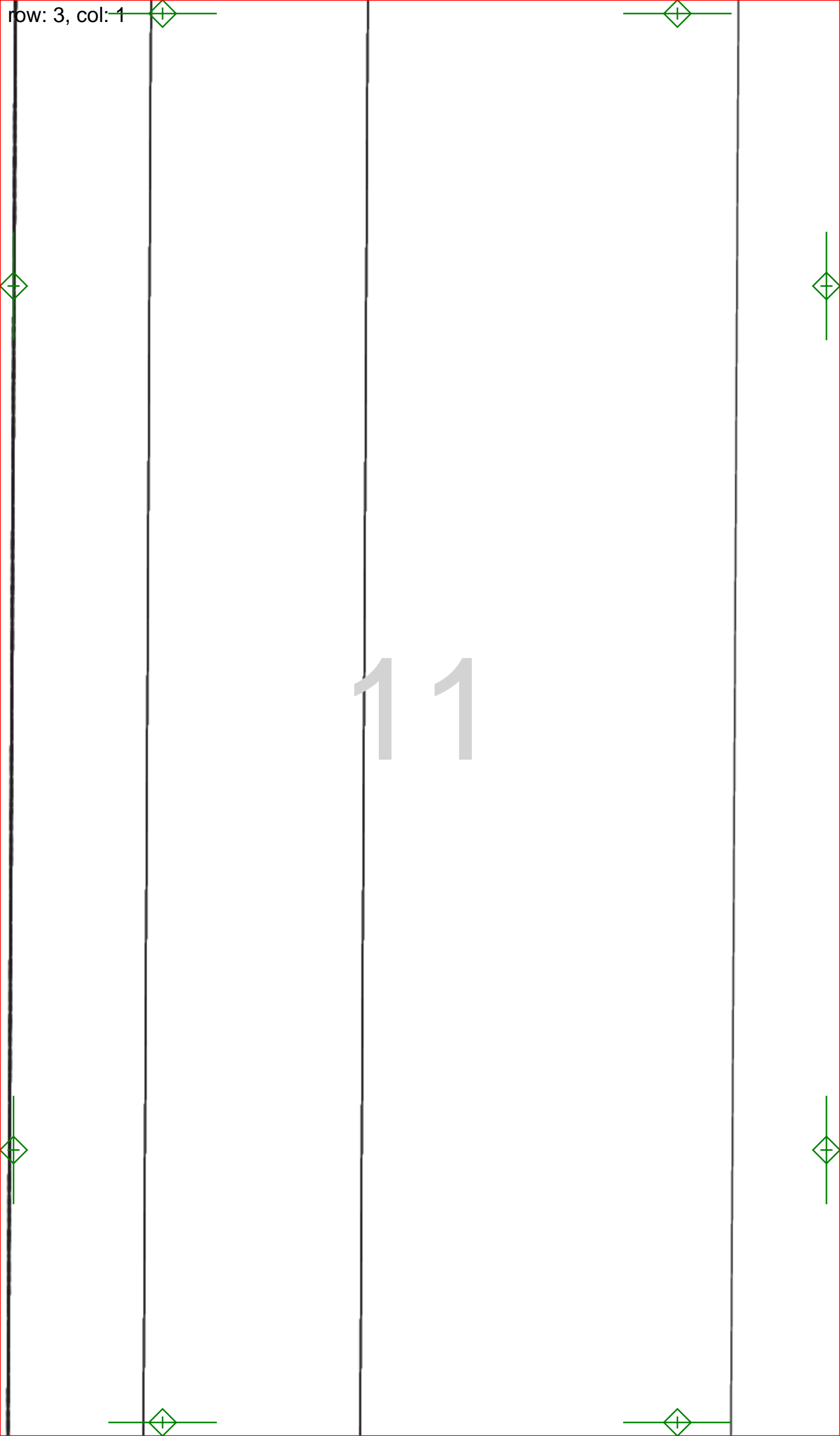

11



12



row: 3, col: 3



13



row: 3, col: 4



14



row: 3, col: 5



15



row: 4, col: 1



16



HEM



17

HEM 1 1/4" (3.2 CM)

LENGTHEN OR

row: 4, col: 3



18

S

M

L

L

M

S

19

HEM 1 1/4" (3.2 CM)



20



LENGTHEN OR SHORTEN HERE



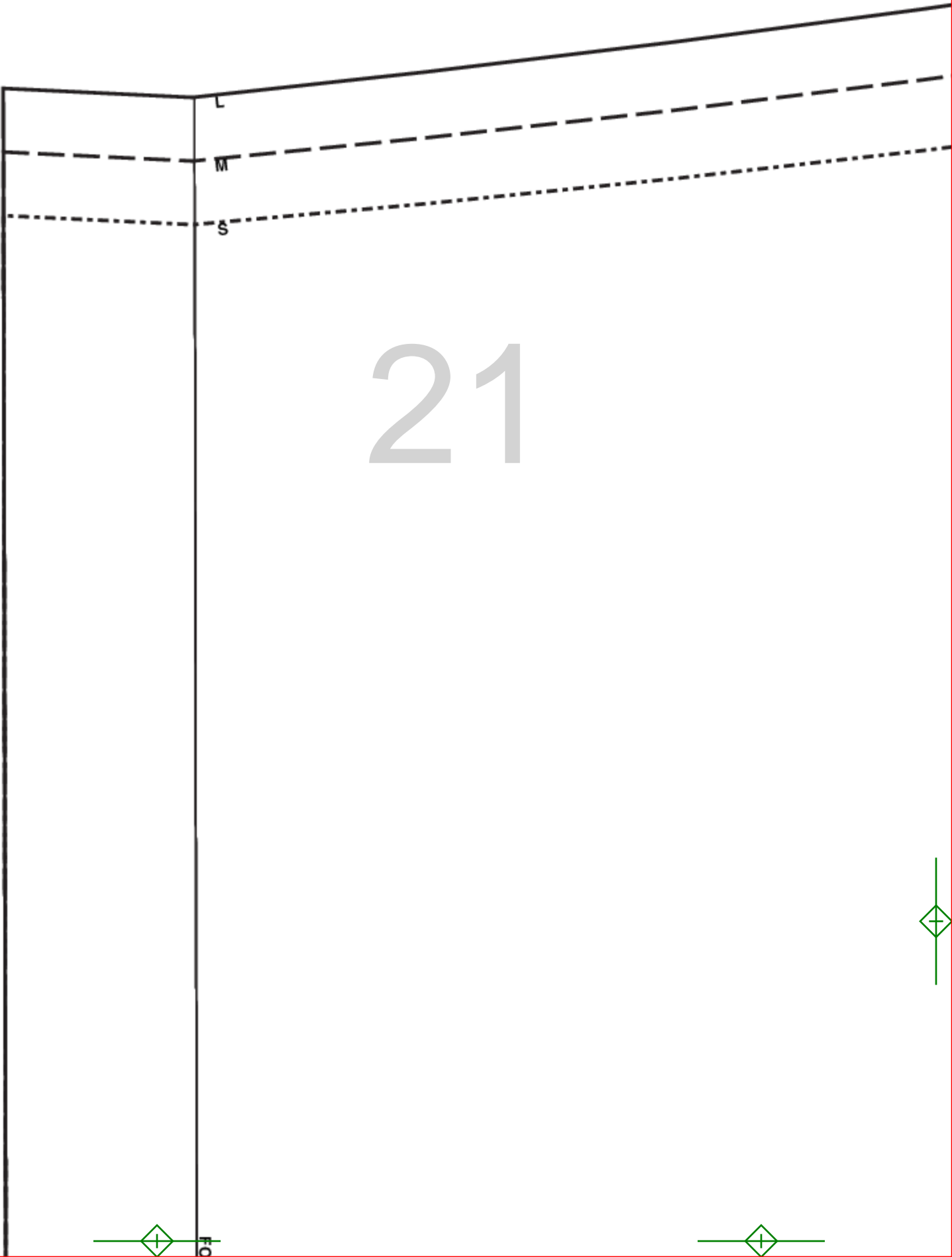

21

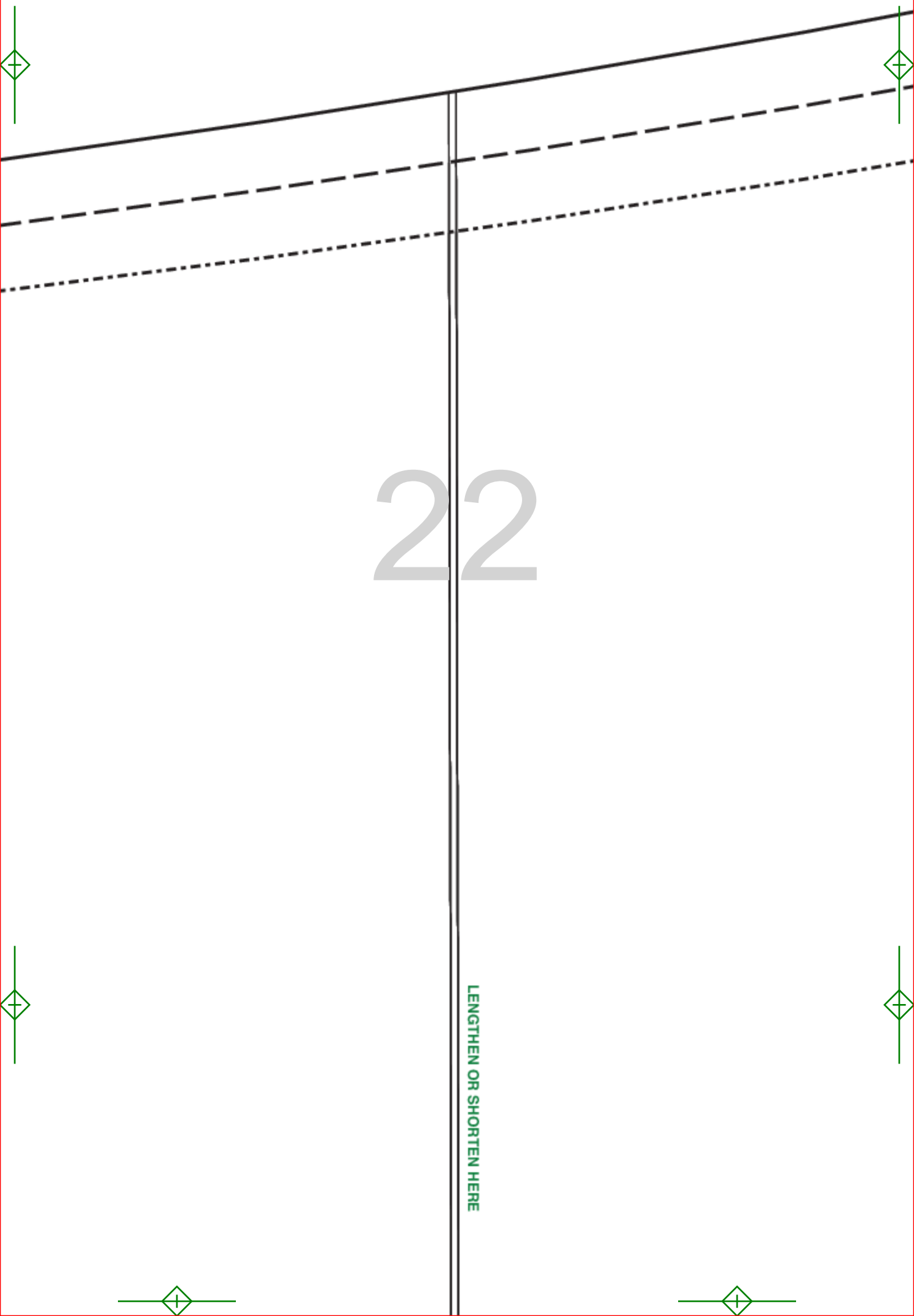

22

LENGTHEN OR SHORTEN HERE

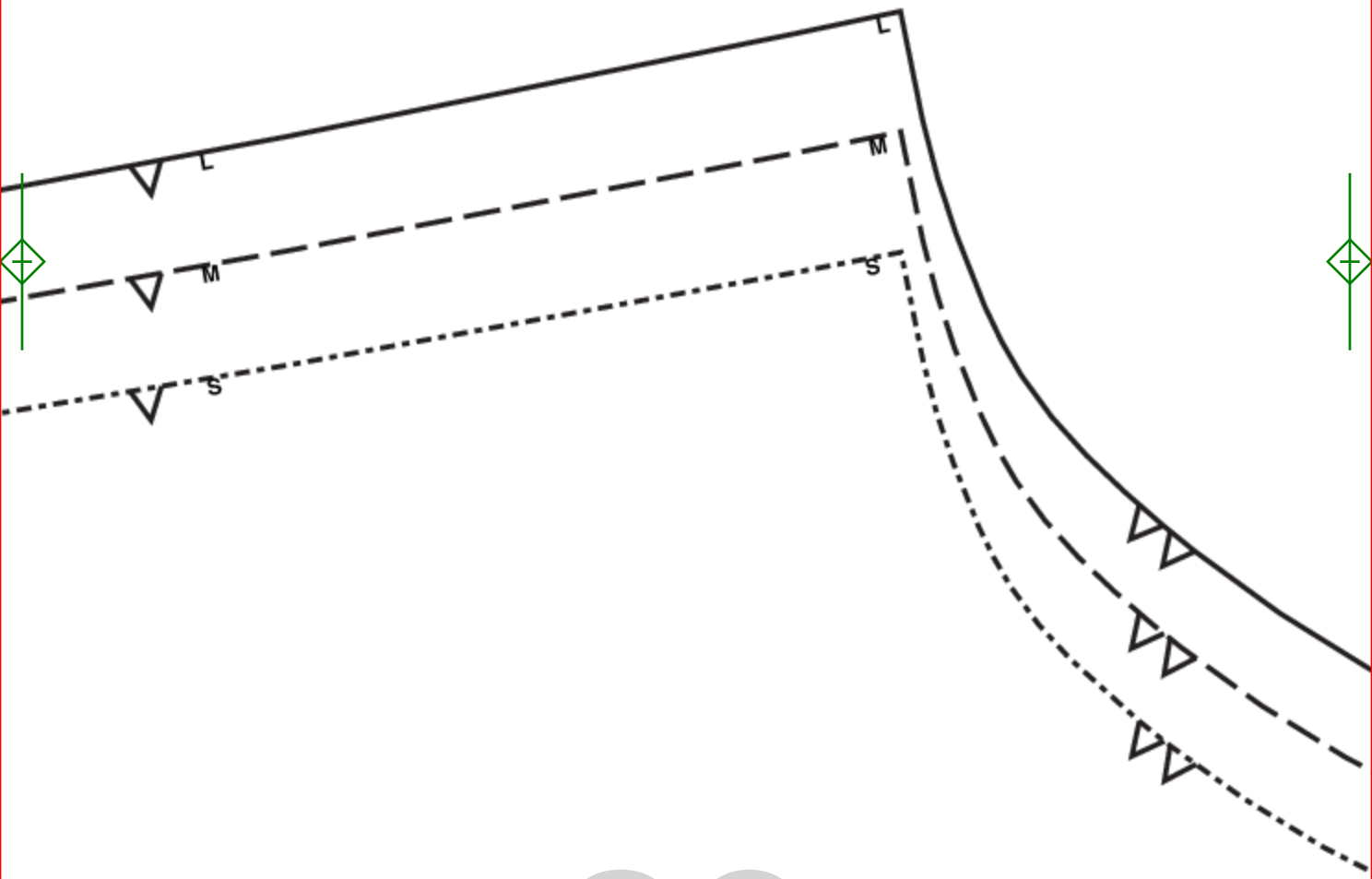

23

24

ARMEL
MANICA

Cut 2

McCall's

M 8170

Men's Sizes A (S-M-L)

L

M

S

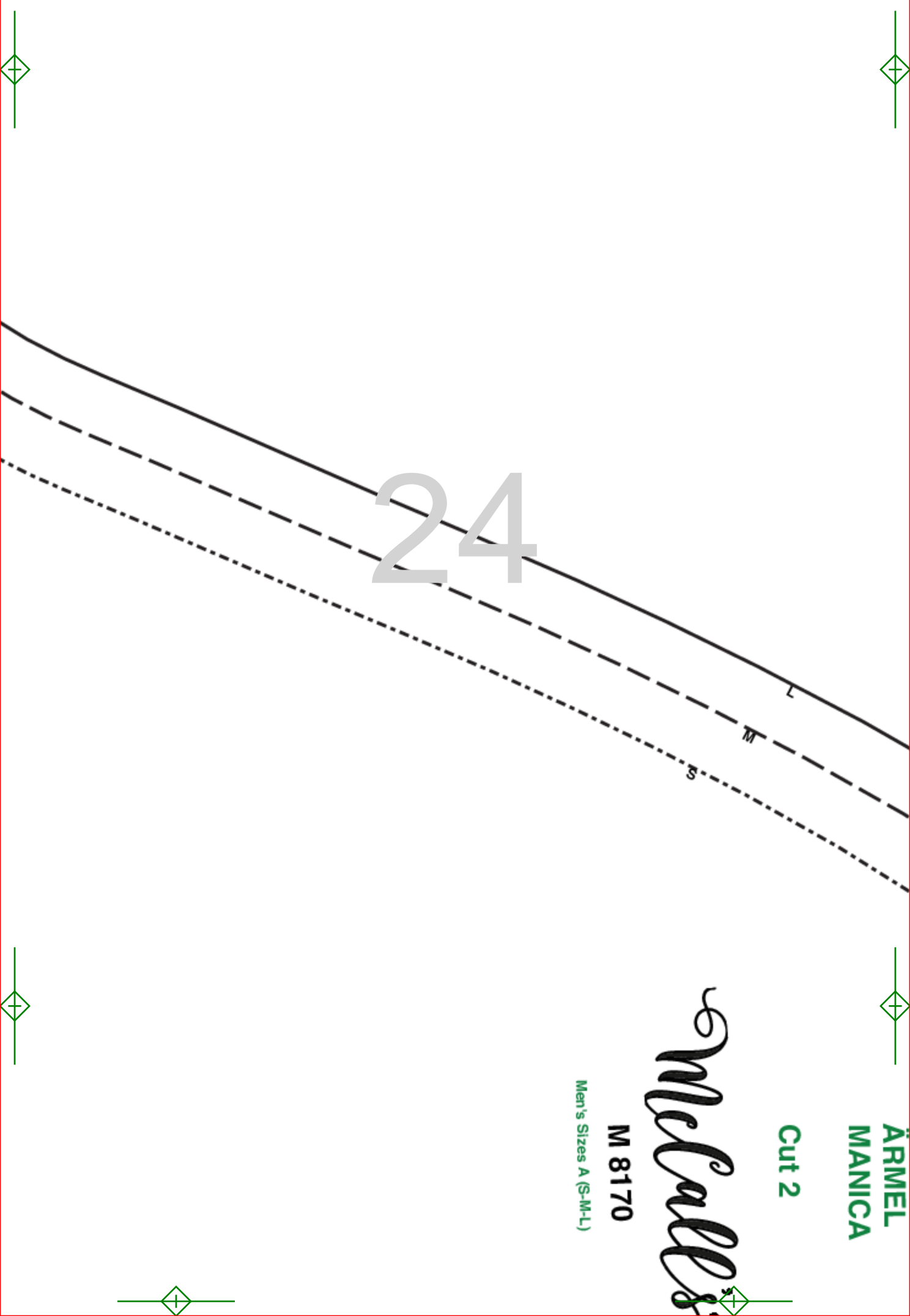

25

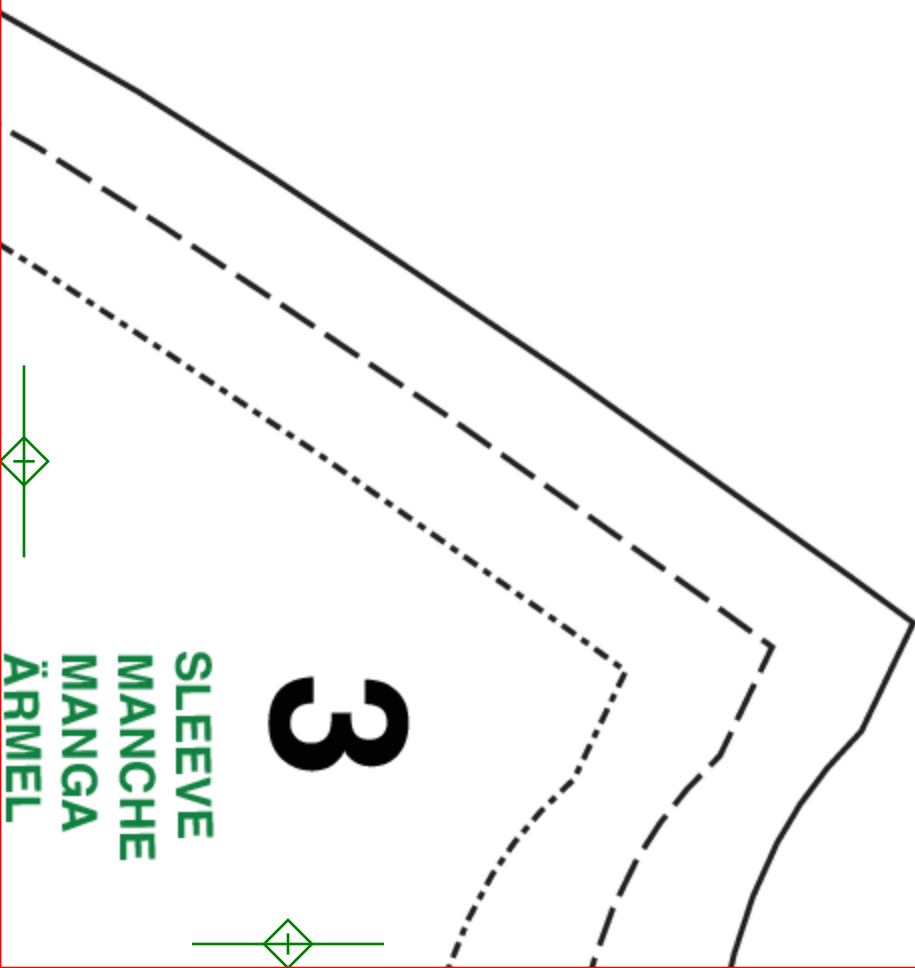

3

SLEEVE
MANCHE
MANGA
ÄRMEL

FOLDLINE

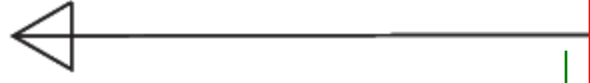

26

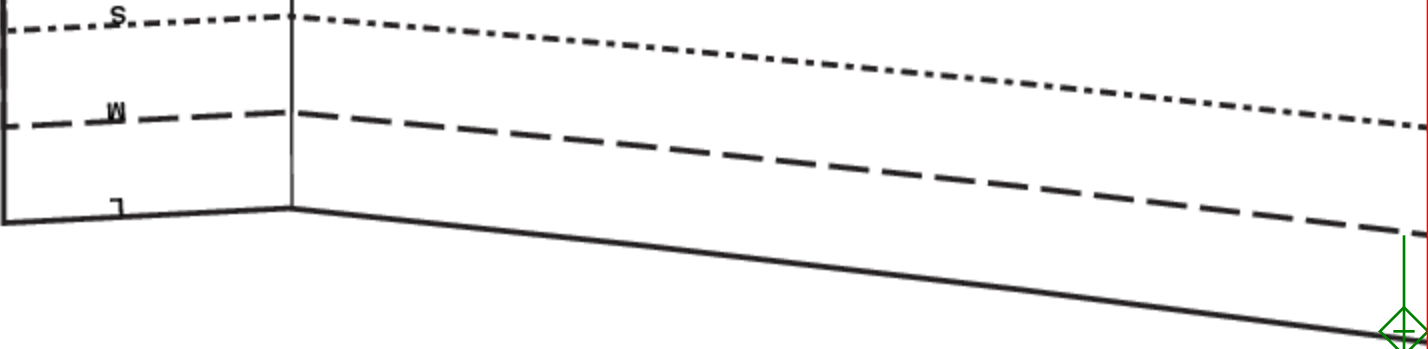



27



21" (53CM)
21 1/2" (54CM)
22" (56CM)



28

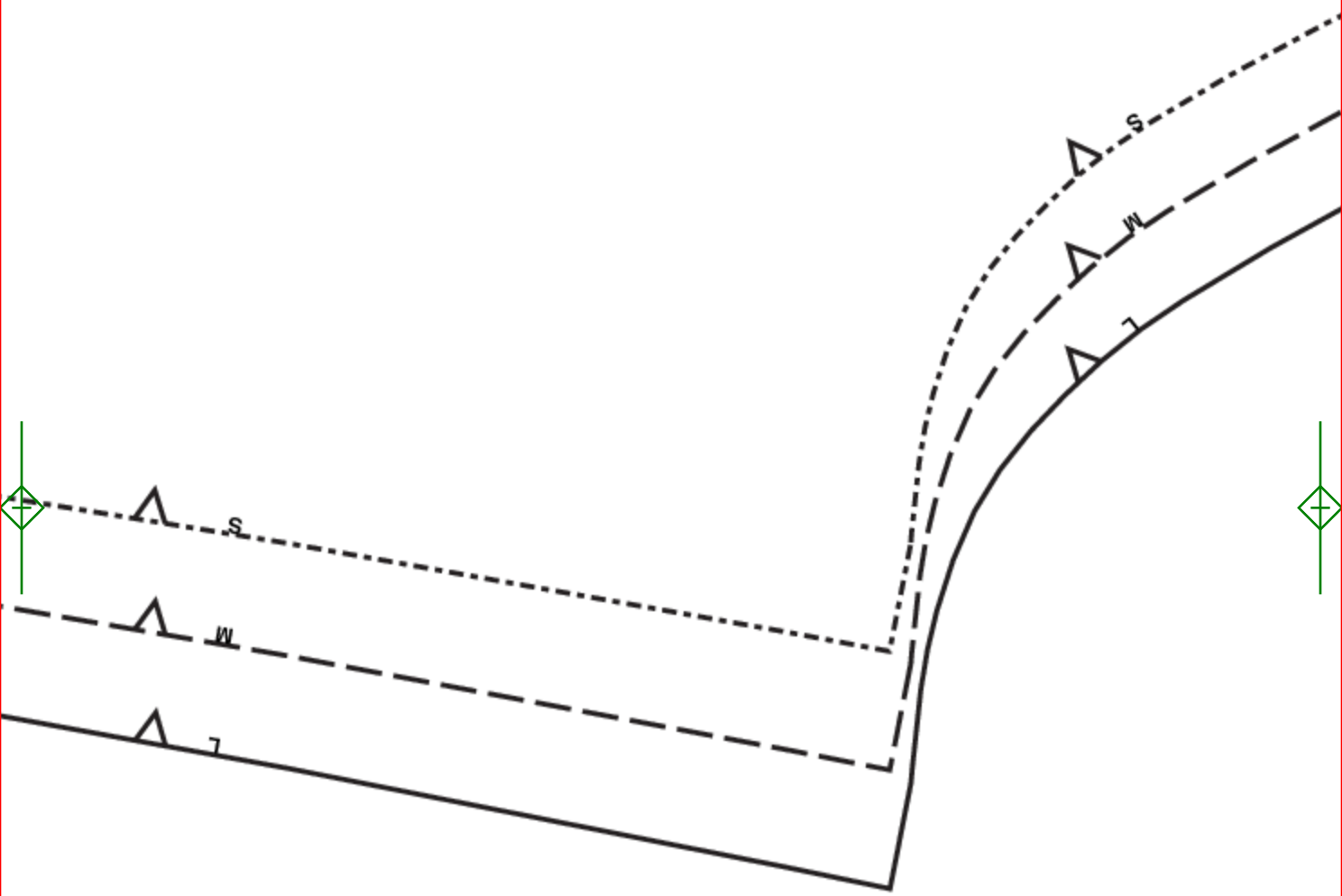



GRAINLINE

29

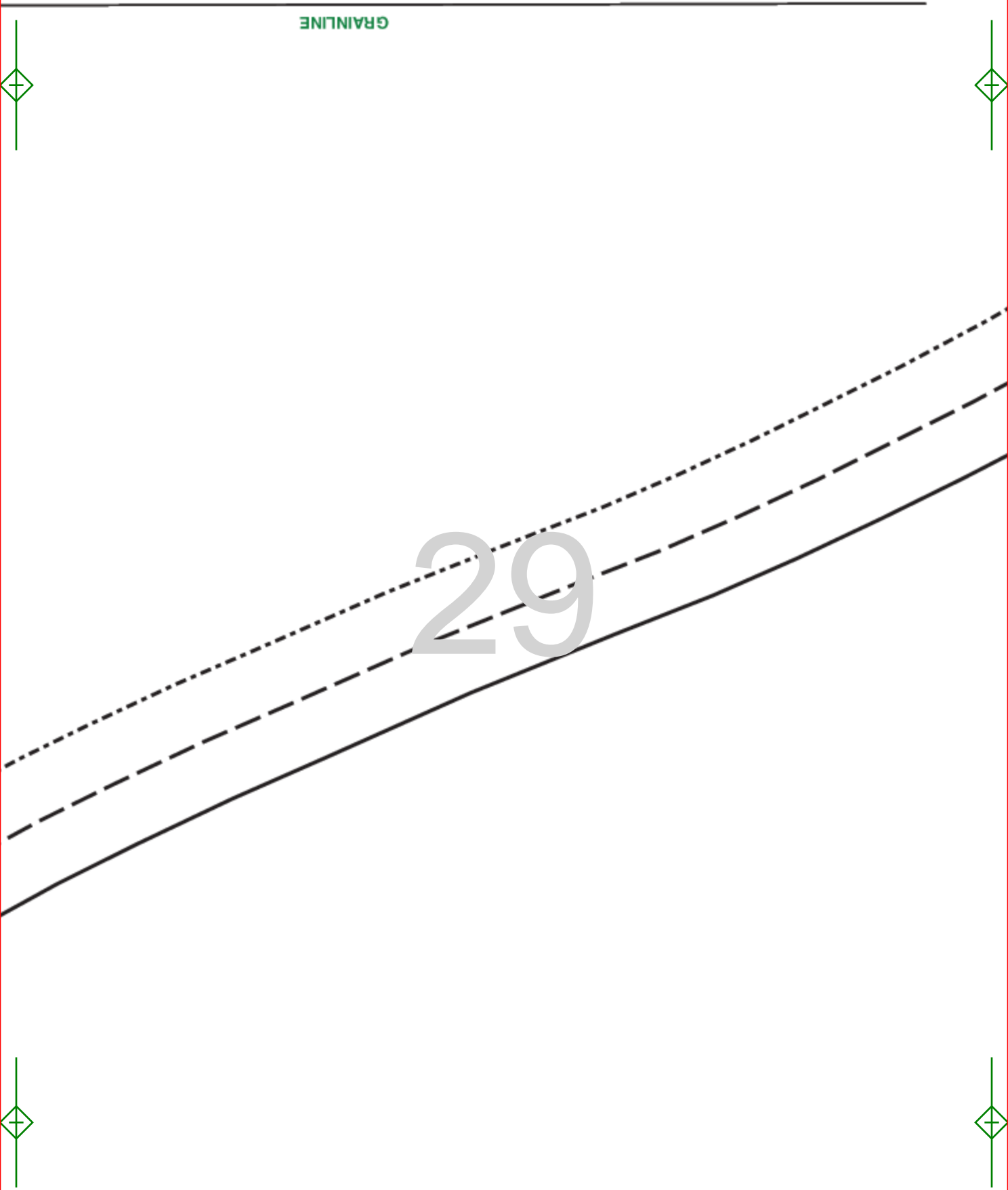

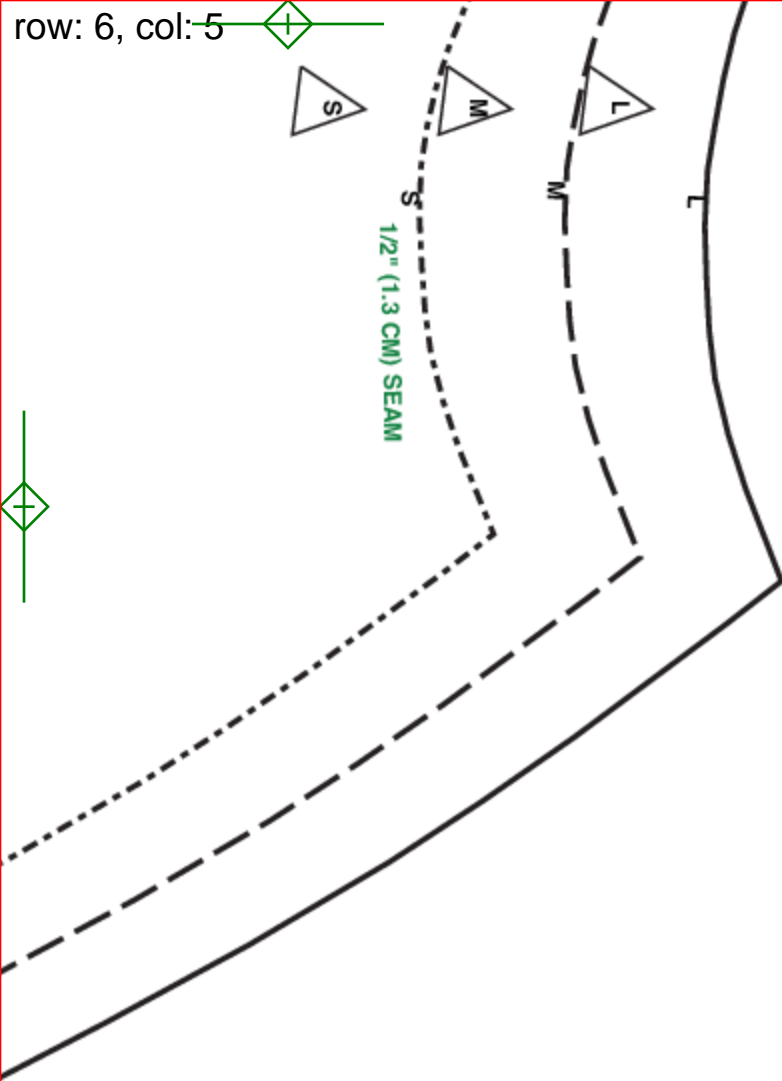

30

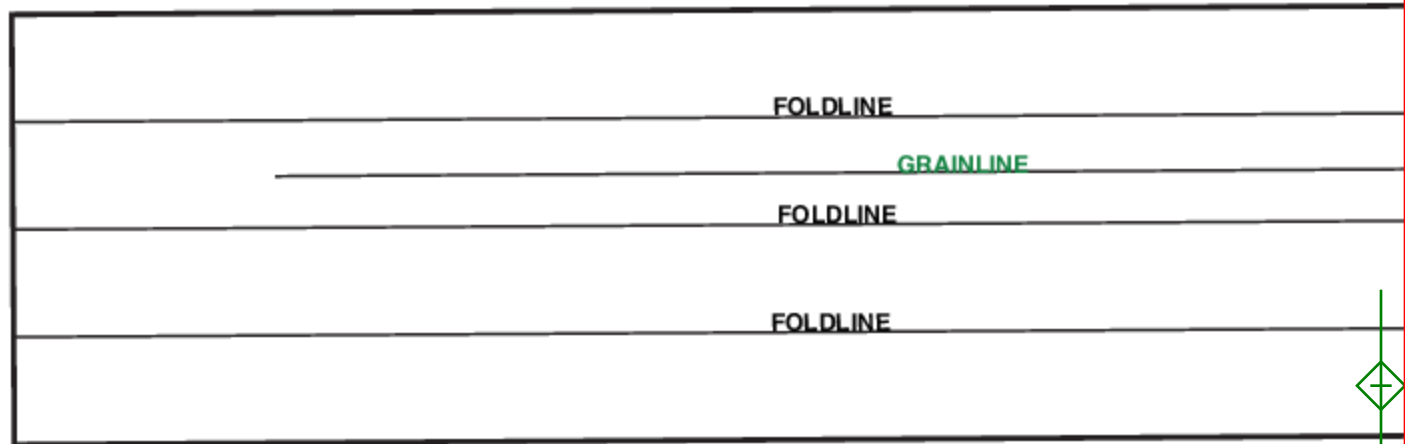

5

TIE END
PAN DE CRAVATE
EXTREMO DE LA CORBATA
ENDE
PUNTE CRAVATTA

Cut 6

McCall's

M 8170

Men's Sizes A (S-M-L)

McCall's

M 8170

Men's Sizes A (S-M-L)

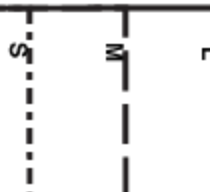

32

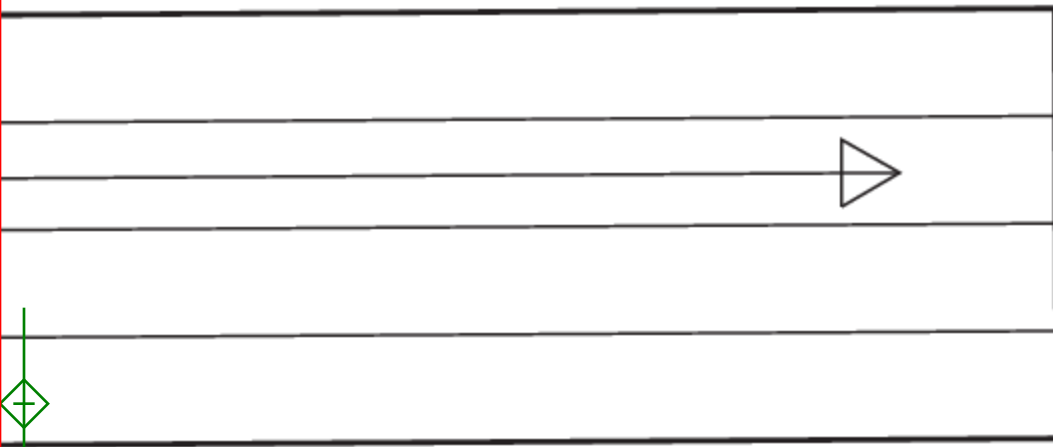

33



34





35

